



The Kololux K6 is a large, high-powered, architectural-grade projector featuring Lumascope's patented Kompass technology that provides the ability to rotate elliptical beams through 360°. Helping to illuminate angled and curved architectural features, sculptural objects and organic natural elements with ease, the technology also provides flexibility in difficult mounting applications enabling the fitting to be mounted on uneven and angled surfaces while providing vertical or horizontal illumination.

Packed with additional features including EasyGlow™ visual comfort, CoolDrive™ thermal management technologies and PowerSync™ allowing for highly granular digital control via common protocols.

Up to 688,100 Candela

Performance

Static White & Color <sup>1</sup>	Lumen Output (lm)	Efficacy (lm/W)	Peak Intensity (cd)
2,700 K (80 CRI)	7,320	89	127,900
3,000 K (80 CRI)	7,940	96	138,800
3,500 K (80 CRI)	7,940	96	138,800
4,000 K (80 CRI)	8,250	100	144,200
5,000 K (70 CRI)	8,250	100	144,200

<sup>1</sup> Lumen output values are based on a 10° lens

Dynamic Color <sup>2</sup>	Lumen Output (lm)	Efficacy (lm/W)	Peak Intensity (cd)
RGBA	4,210	56	72,200
RGBW (4,000 K) with Royal Blue*	4,360	57	76,500

<sup>2</sup> Lumen output values based on a 10° lens

Tunable White <sup>3</sup>	Lumen Output (lm)	Efficacy (lm/W)	Peak Intensity (cd)
2,700 K - 6,500 K	7,780	95	136,100

<sup>3</sup> Lumen output values based on a 10° lens

4.5° Beam Angle (VN Option)

Static White & Color <sup>1</sup>	Lumen Output (lm)	Efficacy (lm/W)	Peak Intensity (cd)
2,700 K (80 CRI)	6,240	76	610,200
3,000 K (80 CRI)	6,770	83	662,100
3,500 K (80 CRI)	6,770	83	662,100
4,000 K (80 CRI)	7,040	86	688,100
5,000 K (70 CRI)	7,040	86	688,100

<sup>1</sup> Lumen output values are based on a 4.5° lens

Beam Angles	4.5°, 5°, 10°, 15°, 30°, 45°, 65°, 40° x 10°, 60° x 10°, 40° x 20°, 60° x 20°
-------------	---

\* NOTE:

The default RGBW colors have recently changed to the RGBW with Royal Blue (4BW code). These colors will not match existing products with the earlier RGBW with Mid-Blue (4CW code). Contact Lumascope for custom LED Colors.



Products and specifications are subject to change without notice. LS9360-241014

**Electrical**

<b>Power Consumption</b>	< 84 W	
<b>Lifetime</b>	>86,935 hrs @122°F (50°C) ambient (B10, L90, TM21 Projected)	
<b>Input Voltage</b>	International	220 to 240 Vac, 50 Hz
	North America	120/277 Vac, 60 Hz
	Low Voltage	48 Vdc
<b>Thermal Management</b>	CoolDrive™ onboard thermal monitoring and control	

**Control**

<b>Interface</b>	Lumascap <b>PowerSync</b> ®	
<b>Protocols<sup>1</sup></b>	DMX/RDM, Artnet, PWM <sup>2</sup> , 0 - 10 V (sink or source) <sup>2</sup>	
<b>PWM Frequency</b>	2 kHz flicker-free dimming to 0.1%	
<b>RDM Functionality</b>	PowerSync enabled Lumascap luminaires are shipped with a default RDM personality which provides smooth dimming control. For different dimming characteristics or to enable other special functionalities, the default personality can be changed through industry standard DMX/RDM.	
<b>Systems</b>	Range of third-party controllers	

<sup>1</sup> Some protocols require additional hardware. For more information and other available protocols contact Lumascap.

<sup>2</sup> Not available for color-changing or tunable white

**Physical**

<b>Housing</b>	Marine-grade die-cast aluminum, tempered glass lens, isolated stainless steel fasteners, adjustable mounting yoke (lockable) with mounting surface galvanic isolator	
<b>Finish</b>	Superior 9-step powder-coating process, including marine-grade epoxy undercoat and polyester top-coat	
<b>Installation</b>	Surface-mounted with included galvanic isolator	
<b>Adjustable</b>	Adjustable mounting yoke	
<b>Ambient Operating Temperature</b>	-40°F to 122°F (-40°C to 50°C)	
<b>Effective Projected Area</b>	1.2 ft <sup>2</sup> (0.1 m <sup>2</sup> )	
<b>Weight</b>	22.9 lb (10.4 kg)	

**Certification & Compliance**

<b>IP Rating</b>	IP66 / IP67 (Passes IP68 test)	
<b>IK Rating</b>	IK10	
<b>Vibration Resistance</b>	3G Rating (ANSI C136.31) <i>With optional 3G Bracket</i>	
<b>Environment</b>	Dry, Damp, Wet locations	
<b>Certifications</b>	UL, CE, RCM, FCC	

Elliptical Beam Adjustment



Dimensions

K6 with standard bracket

K6 with 3G bracket

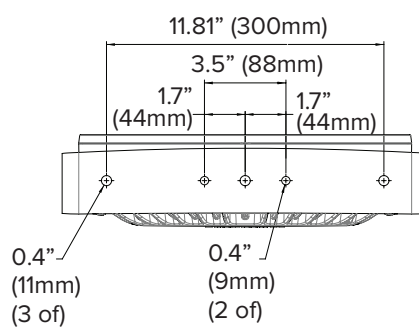
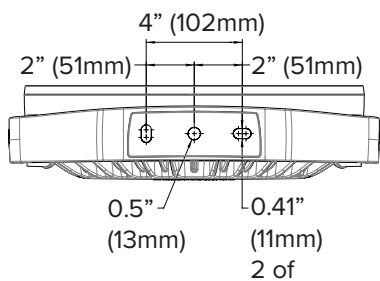
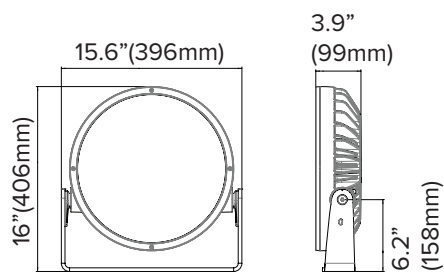
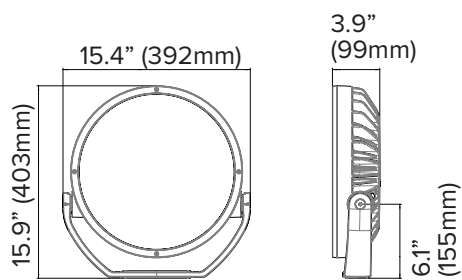

Projector Specification Matrix

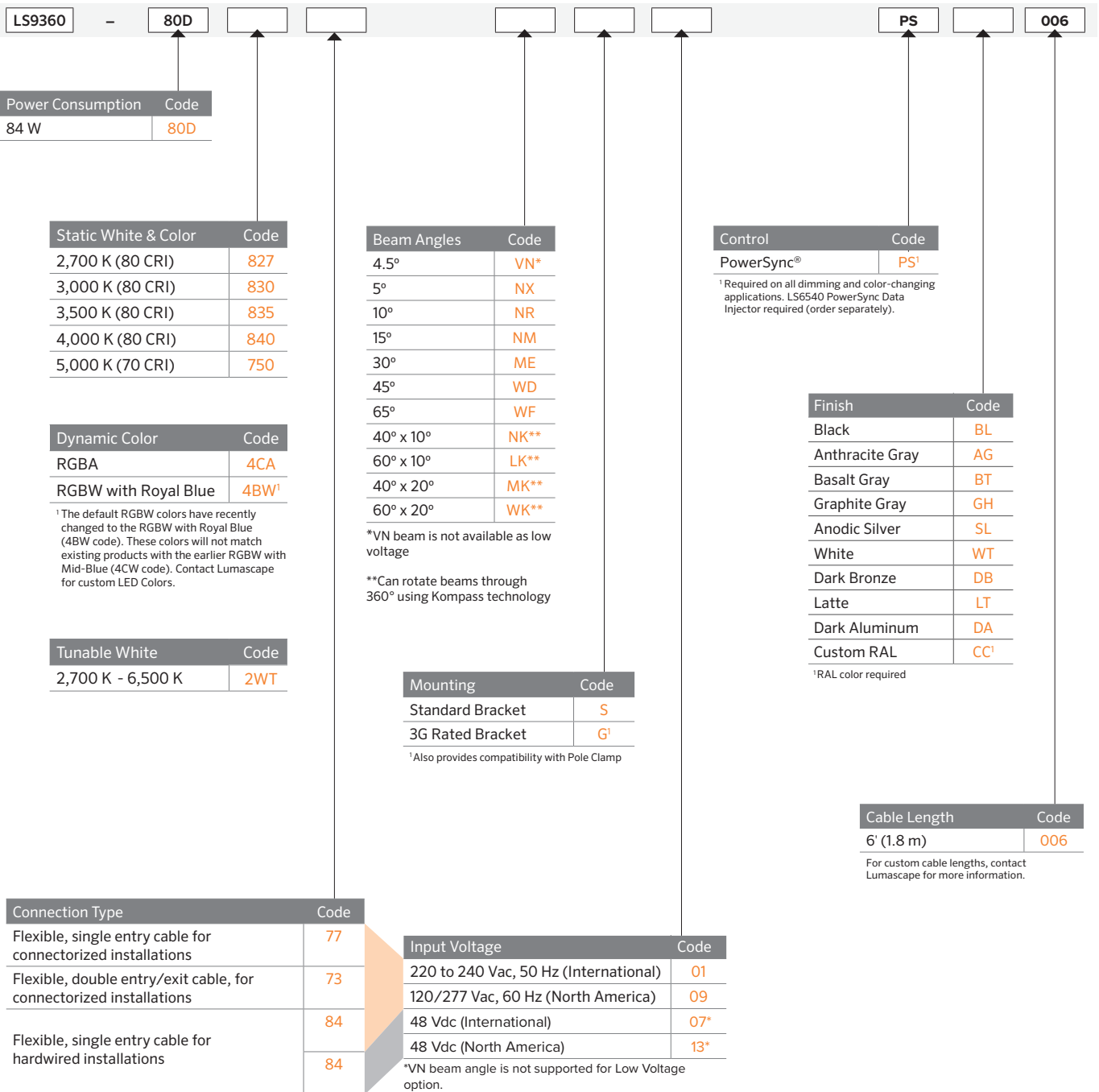

Power Consumption	Code
84 W	80D

Static White & Color	Code
2,700 K (80 CRI)	827
3,000 K (80 CRI)	830
3,500 K (80 CRI)	835
4,000 K (80 CRI)	840
5,000 K (70 CRI)	750

Dynamic Color	Code
RGBA	4CA
RGBW with Royal Blue	4BW <sup>1</sup>

<sup>1</sup> The default RGBW colors have recently changed to the RGBW with Royal Blue (4BW code). These colors will not match existing products with the earlier RGBW with Mid-Blue (4CW code). Contact Lumascape for custom LED Colors.

Tunable White	Code
2,700 K - 6,500 K	2WT

Beam Angles	Code
4.5°	VN*
5°	NX
10°	NR
15°	NM
30°	ME
45°	WD
65°	WF
40° x 10°	NK**
60° x 10°	LK**
40° x 20°	MK**
60° x 20°	WK**

\*VN beam is not available as low voltage

\*\*Can rotate beams through 360° using Kompass technology

Mounting	Code
Standard Bracket	S
3G Rated Bracket	G <sup>1</sup>

<sup>1</sup>Also provides compatibility with Pole Clamp

Control	Code
PowerSync®	PS <sup>1</sup>

<sup>1</sup> Required on all dimming and color-changing applications. LS6540 PowerSync Data Injector required (order separately).

Finish	Code
Black	BL
Anthracite Gray	AG
Basalt Gray	BT
Graphite Gray	GH
Anodic Silver	SL
White	WT
Dark Bronze	DB
Latte	LT
Dark Aluminum	DA
Custom RAL	CC <sup>1</sup>

<sup>1</sup>RAL color required

Cable Length	Code
6' (1.8 m)	006

For custom cable lengths, contact Lumascape for more information.

Connection Type	Code
Flexible, single entry cable for connectorized installations	77
Flexible, double entry/exit cable, for connectorized installations	73
Flexible, single entry cable for hardwired installations	84
	84

Input Voltage	Code
220 to 240 Vac, 50 Hz (International)	01
120/277 Vac, 60 Hz (North America)	09
48 Vdc (International)	07*
48 Vdc (North America)	13*

\*VN beam angle is not supported for Low Voltage option.

Pendant Specification Matrix

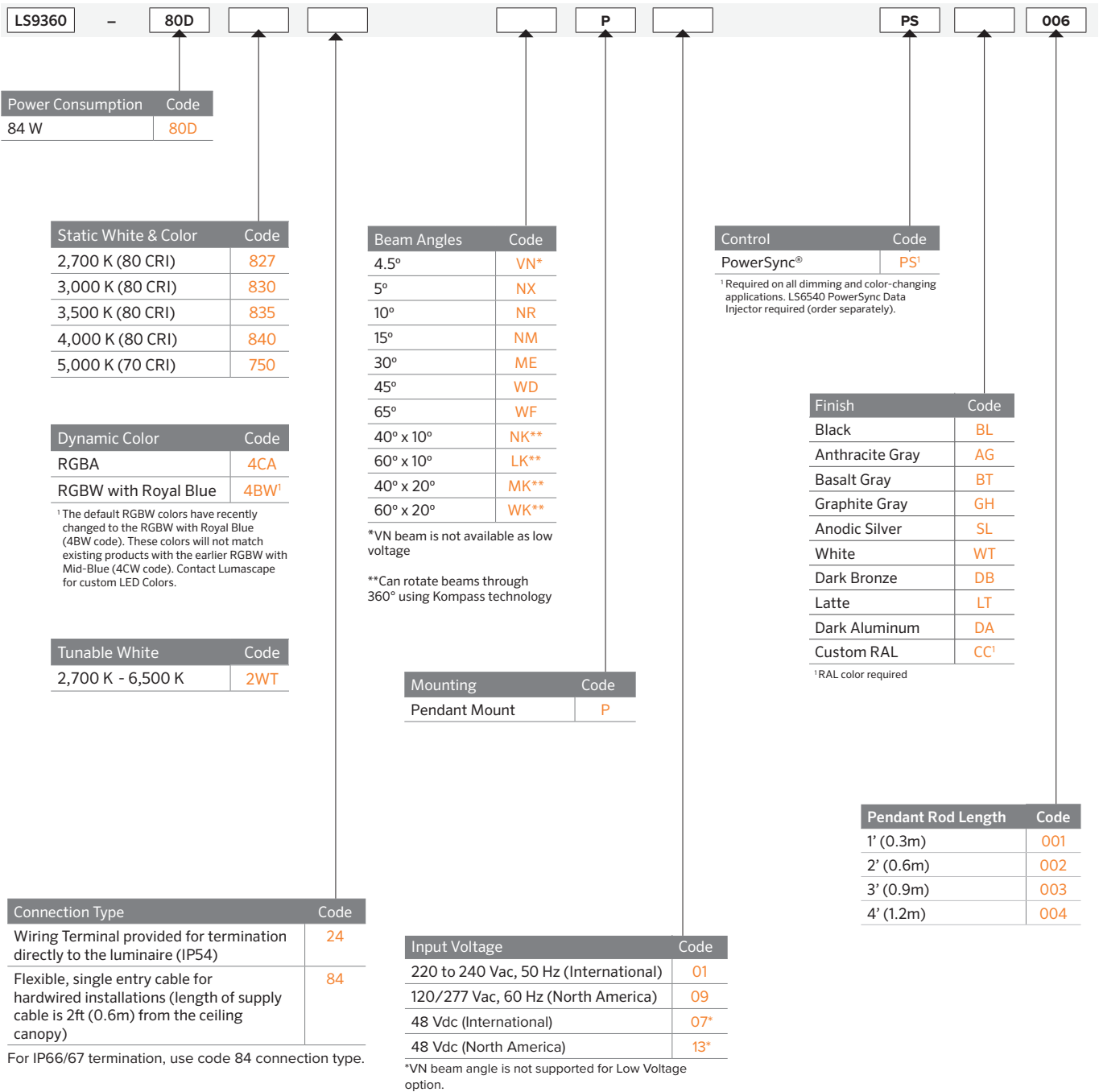

Accessories

Shielding & Glare Control

A range of shielding and glare control accessories are available to suit the Kololux K6 Spotlight.

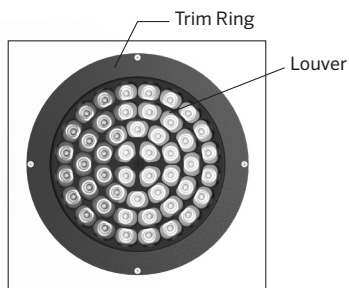

**LS6252** Cross Hatch Louvre

Provides additional glare control. Can be used with LS6253 (30° Visor) or LS6254 (Snoot). Louver is available in black only, trim ring is available in standard finishes.

**LS6253** 30° Visor

Provides additional beam control and shielding.

**LS6254** Snoot

Provides additional glare control.

Specification Matrix

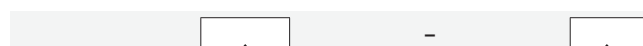

Louver Length	Code
Snoot	LS6254
30° Visor	LS6253
Cross Hatch Louver	LS6252

Custom Visors are available on request. Contact Lumascape for more information.

Finish	Code
Black	BL
Anthracite Gray	AG
Basalt Gray	BT
Graphite Gray	GH
Anodic Silver	SL
White	WT
Dark Bronze	DB
Latte	LT
Dark Aluminum	DA
Custom RAL	CC <sup>1</sup>

<sup>1</sup>RAL color required

Technical Drawings

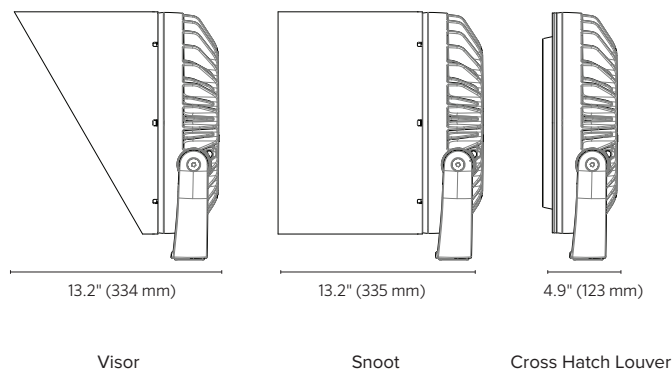

Pendant Mount



Pendant Mount with  
Cross Hatch Louvre  
(LS6252)

**Pendant Mount** Available in 1' (0.3m), 2' (0.6m), 3' (0.9m) and 4' (1.2m) rod lengths.

Mounting Accessories



**Pole Clamp** (3G bracket must be used when using this mounting option)  
 Provides an easy method of installing the fixture onto a pole, while retaining full aiming and adjustability. Available in 3.0" (76 mm), 4.0" (102 mm), 4.5" (114 mm) and 5.0" (127 mm) options.  
 LS6317, LS6318, LS6319, LS6320

NOTE:

3G Bracket **MUST** be used when using this mounting option

Specification Matrix

		-		
		↑		
Mounting Accessories		Code	Finish	
3.0" (76 mm) Pole Clamp		LS6317	Black	BL
4.0" (102 mm) Pole Clamp		LS6318	Anthracite Gray	AG
4.5" (114 mm) Pole Clamp		LS6319	Basalt Gray	BT
5.0" (127 mm) Pole Clamp		LS6320	Graphite Gray	GH
			Anodic Silver	SL
			White	WT
			Dark Bronze	DB
			Latte	LT
			Dark Aluminum	DA
			Custom RAL	CC <sup>1</sup>

Luminaire must be ordered with a 3G rated bracket.

<sup>1</sup>RAL color required



**Wall/Pole Arm** Minimum 3.0" (76 mm) to maximum pole or wall.  
 LS6258

Specification Matrix

		LS6258	-				
		↑					↑
Mounting Accessories		Code	Model		Code	Finish	
Minimum 3.0" (76 mm) to maximum pole or wall. Pole/Wall mount arm		LS6258	K6 with standard bracket	S		Black	BL
			K8 with standard bracket	8		Anthracite Gray	AG
			K6/K8 with 3G rated bracket	G		Basalt Gray	BT
						Graphite Gray	GH
						Anodic Silver	SL
						White	WT
						Dark Bronze	DB
						Latte	LT
						Dark Aluminum	DA
						Custom RAL	CC <sup>1</sup>

<sup>1</sup>RAL color required



Network Topology – Line Voltage 220 to 240 Vac, 120/277 Vac Dimmable and Color-Changing via PowerSync® 4

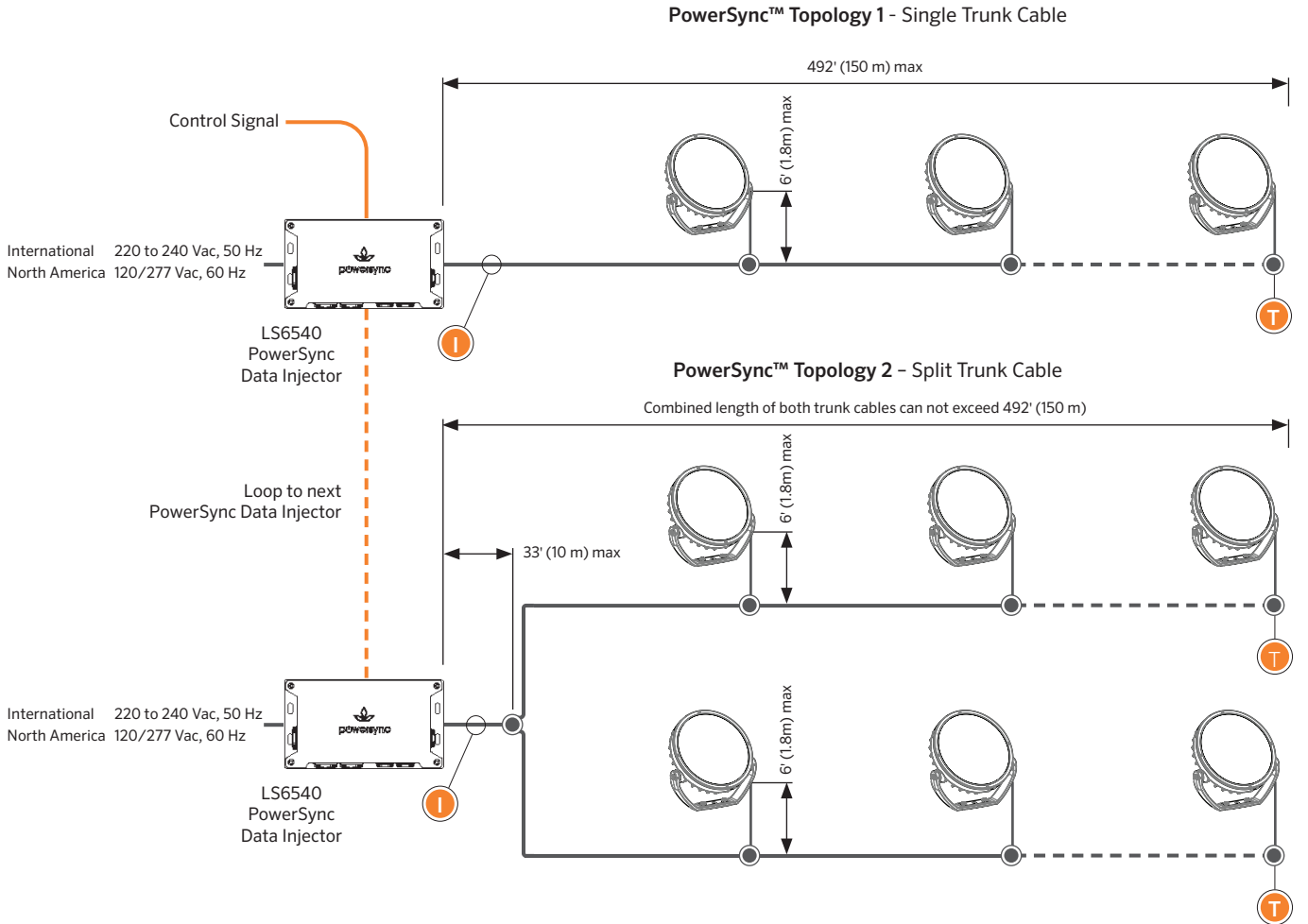

Up to 42 luminaires per run under the following conditions:

- Max total cable run length 492' (150 m) in up to two trunk cables.
- For run lengths in excess of 100' (30 m), the data wire gauge cannot exceed 14 AWG (2.5 mm<sup>2</sup>).
- For run lengths up to 100' (30 m), the data wire gauge is not governed.
- Refer to 'Maximum Circuit Load' table for circuit limitations.
- Always observe local electrical codes for branch circuit current limitations.

Maximum Circuit Load

Maximum Number of Fixtures per Circuit		
Voltage	Maximum Current	
	12.8 A	16 A
120 V	14	18
240 V	30	34
277 V	35	42

Refer to PowerSync™ installation instructions for maximum distance information and topology options.

Above circuit loading limits are based on maximum circuit current capacity. Cumulative earth leakage and voltage drop may need to be calculated.

For non-continuous runs contact Lumascape for more details.

- T** Terminator  
Use PowerSync™ terminator, supplied with leader cable to terminate last luminaire in chain.
- I** Maximum Current  
Maximum current through cables and connectors supplied by Lumascape:  
≤12.8 A - Installations in North American Market (UL, ETL)  
≤16 A - Installations in International Market (CE, UKCA)
- Connection Type  
Circuits can be configured as either connectorized or hardwired. For details refer to installation instructions and comply with local electrical codes.

Network Topology – Low Voltage PowerSync™

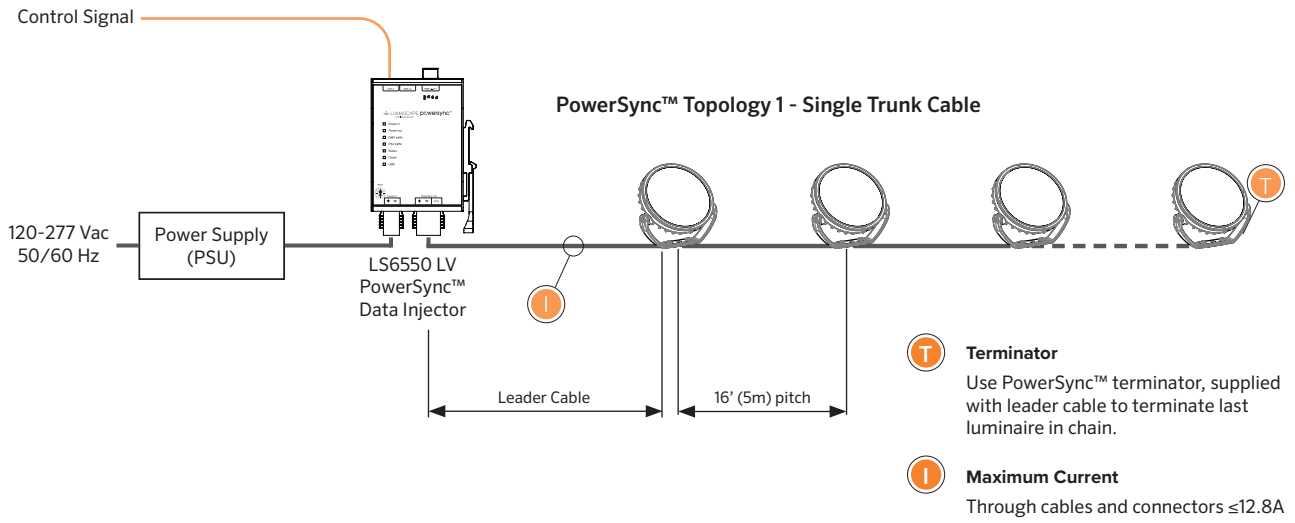

LS6550 Low Voltage PowerSync Injector

Maximum Circuit Loading - Single Run					
Beam Angle	Power Supply	Max Leader Cable Length from LS6550 to first fitting	Maximum number of luminaires per 30/48V power supply		
			320 W	480 W	600 W
NX, NR, NM, ME, WD, WF, NK, LK, MK, WK	48V	50 ft / 15 m	3	4	4
		98 ft / 30 m	2	2	2
		164 ft / 50 m	1	1	1
VN	30V	164 ft / 50 m	1	1	1

Values in the above table show the maximum circuit loading for luminaires with a NX, NR, NM, ME, WD, WF, NK LK, MK and WK beam angle per 48 V circuit. Values in the above table show the maximum circuit loading for luminaires with a VN beam angle per 30 V circuit. Values are based on 16ft (5m) spacings. Extended fixture cables, inclusion of longer jumper cables, or longer leader cable will effect loading. Circuits can be made up of up the maximum number of luminaires per maximum circuit loading in the table above. Circuits are limited to maximum 12.8A. For non-continuous runs, contact Lumascape for details. To calculate the maximum number of interconnected luminaires per run / circuit, see example below.

For assistance, contact Lumascape. Always observe electrical codes.

Connectorized Accessories - Line Voltage 220 to 240 Vac

**Leader Cables - PowerSync Line Voltage 220 to 240 Vac**

4-core 1.5 mm<sup>2</sup> or 2.5mm<sup>2</sup> for use in CE/CCC installations. Compatible with all luminaires with Type 73 or 77 connectorized supply cable options. Supplied fitted with an IP68 connector for pairing with the first connectorized luminaire in a Powersync4, Line Voltage circuit. Comes complete with a matching End of Circuit, Powersync4, Line Voltage, Terminator Plug.

*Not suitable for use in North America*

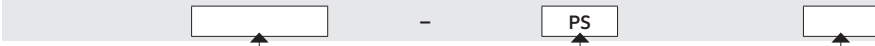

Cable Type	Code	Cable Type	Code	Length	Code
1.5 mm <sup>2</sup>	LS6402C	PowerSync	PS	10' (3 m)	010
2.5 mm <sup>2</sup>	LS6402C-2.5			32' (10 m)	032
				50' (15 m)	050

**Jumper Cables - PowerSync Line Voltage 220 to 240 Vac**

4-core 1.5 mm<sup>2</sup> or 2.5mm<sup>2</sup> for use in CE/CCC installations. Compatible with all luminaires with Type 73 or 77 connectorized supply cable options. Supplied fitted with an IP68 connector for pairing with the first connectorized luminaire in a Powersync4, Line Voltage circuit.

*Not suitable for use in North America*



Cable Size	Code	Cable Type	Code	Length	Code
1.5 mm <sup>2</sup>	LS6404C	PowerSync	PS	1' (0.3 m)	001
2.5 mm <sup>2</sup>	LS6404C-2.5			2' (0.6 m)	002
				3' (1 m)	003
				4' (1.2 m)	004
				6' (2 m)	006
				10' (3 m)	010
				16' (5 m)	016
				26' (26 m)	026
				32' (10 m)	032
				50' (15 m)	050

Connectorized Accessories - Line Voltage 120/277 Vac

**Leader Cables - PowerSync Line Voltage 120/277 Vac (For Connection Type 77 Only)**

4 conductors 14 AWG for use in UL installations. Compatible with Type 77 connectorized supply cable options. Supplied fitted with an IP68 connector for pairing with the first connectorized luminaire in a Powersync4, Line Voltage circuit. Comes complete with a matching End of Circuit, Powersync4, Line Voltage, Terminator Plug.

For use in North America ONLY

LS6402U		-	PS		
Cable Type	Code	Cable Type	Code	Length	Code
14 AWG	LS6402U	PowerSync	PS	10' (3 m)	010
				33' (10 m)	033
				50' (15 m)	050

**Jumper Cables - PowerSync Line Voltage 120/277 Vac (For Connection Type 77 Only)**

4-core 14 AWG for use in UL installations. Compatible with all Luminaires with Type 77 connectorized supply cable options. Supplied fitted with an IP68 connector for pairing with the first connectorized luminaire in a Powersync4, Line Voltage circuit.

For use in North America ONLY

LS6404U		-	PS		
Cable Size	Code	Cable Type	Code	Length	Code
14 AWG	LS6404U	PowerSync	PS	1' (0.3 m)	001
				2' (0.6 m)	002
				3' (1 m)	003
				4' (1.2 m)	004
				6' (2 m)	006
				10' (3 m)	010
				16' (5 m)	016
				26' (26 m)	026
				33' (10 m)	033
				50' (15 m)	050

Connectorized Accessories

Terminators

Product	Code
DMX Terminator Hardwired	LS6407
PowerSync Terminator Hardwired, Line Voltage 220 to 240 Vac	LS6406-01
PowerSync Terminator Hardwired, Line Voltage 120/277 Vac	LS6406-09
PowerSync Terminator Connectorized, Line Voltage 220 to 240 Vac, 120/277 Vac	LS6417

\* NOTE:

- DMX Terminators ship with PowerSync Data Injectors.
- Terminators for hardwired PowerSync installations ship with PowerSync Data Injectors.
- Terminators for connectorized PowerSync installations ship with Leader Cables.
- Order separately for spares only.

PowerSync Line Voltage 220 to 240 Vac, 120/277 Vac Data Injector

Combines the convenience of standard wiring methods to translate control signals into a digital format that can be transmitted over standard copper wire. This allows highly granular addressing and high-speed digital control of every luminaire, using only four wires and accepts a growing list of standard protocols (0-10 V, DMX / RDM), for simple integration with a wide selection of control systems using these industry standard protocols.

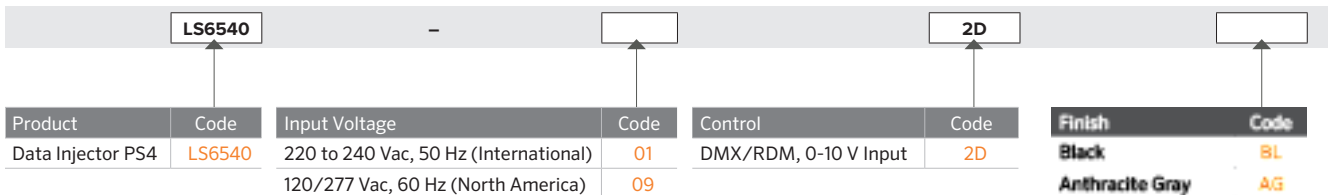

NOTE:

PowerSync Data Injector ships with three (3) hardwired terminators and one (1) hardwired DMX terminator.

\*RAL color required

Luminaire Wire Colors & Designations

Line Voltage 220 to 240 Vac - International

Designation	Color
Line	Brown
Neutral	Blue
Ground/Earth	Green / Yellow
Data	Black

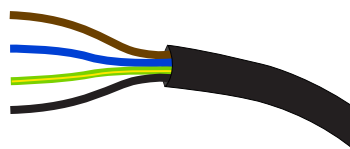

Line Voltage 120/277 Vac - North America

Designation	Color
Line	Black
Neutral	White
Ground/Earth	Green / Yellow
Data	Orange or Red

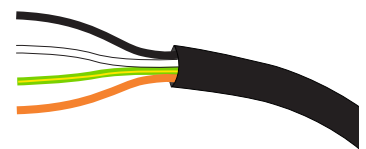

Connectorized Accessories – Low Voltage 30-48 Vac

Terminators

Product	Code
DMX Terminator RJ45, Low Voltage 30 to 48 Vdc (CE, UL)	LS6407-R
Powersync Terminator, Low Voltage 30 to 48 Vdc (CE, UL) Hardwired	LS6406

\* NOTE:

- DMX Terminators ship with PowerSync Data Injectors.
- Terminators for hardwired PowerSync installations ship with PowerSync Data Injectors.
- Terminators for connectorized PowerSync installations ship with Leader Cables.
- Order separately for spares only.

PowerSync Low Voltage 30 to 48 Vdc Data Injector

Translates control signals into a digital format, delivering integral power and data to intelligent LED luminaires. This allows highly-granular addressing and high-speed digital control of every luminaire, using only three wires. The data injector is DIN rail mountable designed to be installed in a switchboard, next to the power supply and circuit breaker that is supplying power to the controlled lighting circuit. Accepts a growing list of standard protocols (0-10 V, DMX/RDM) for simple integration with a wide selection of control systems using these industry standard protocols.

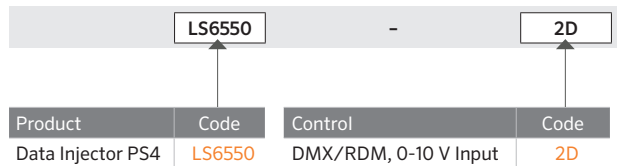

NOTE:

PowerSync Data Injector ships with three (3) hardwired terminators and one (1) hardwired DMX terminator.

Fixture Colors & Wiring Designations

Low Voltage

Designation	Color
+ DC	Red
- DC	Black
Data	Orange

