

# ERDEN E4 LS3042 Foundation



EN

Please read and follow all safety instructions carefully. Failure to do so will void warranty.

**WARNING – Product Warranty is void if product is not installed as per installation instructions and in compliance with all local and provincial codes.**

- › Ensure installation complies with local electrical rules and regulations.
- › All electrical work must be performed by a licensed electrician.
- › Protective earth, protective ground (symbol 7).
- › All luminaires may become hot. Use discretion on where the luminaire is mounted. Take care when setting luminaires as it may become hot.
- › Luminaire should only be used complete with protective shield. If protective shield is cracked, immediately stop using luminaire. Isolate light source, keep it dry and immediately contact Lumascape for replacement of protective shield (symbol 11).
- › If the external flexible cable or cord of this luminaire is damaged, it shall be exclusively replaced by Lumascape or their service agent in order to avoid a hazard.
- › The light source contained in this luminaire shall only be replaced by Lumascape or their service agent.
- › Do not stare at the operating light source. The luminaire should be positioned so that prolonged staring into the luminaire at a distance closer than **23' (7 m)** is not expected (symbol 13)
- › Basic insulation has been maintained between line voltage and the control conductors.
- › To reduce the risk of strangulation the flexible wiring connecting to this luminaire shall be effectively fixed to the wall if the wiring is within arm's reach.
- › Ensure mains input power is surge protected.
- › Never make or break connections while the circuit is energized.
- › Do not make modifications or alter the product.
- › Keep luminaire clean and free of debris.
- › Only clean with warm water.
- › Do not use chemicals or abrasives to clean luminaire as this may void the product warranty.
- › Connections are to be kept clean and dry at all times.
- › Suitable for use indoors or outdoors.

FR

Veillez lire et suivre attentivement toutes les instructions de sécurité. Le non-respect de cette consigne annulera la garantie.

**AVERTISSEMENT - La garantie du produit est annulée si le produit n'est pas installé conformément aux instructions d'installation et en conformité avec tous les codes locaux et provinciaux.**

- › Assurez-vous que l'installation est conforme aux règles et réglementations électriques locales.
- › Tous les travaux électriques doivent être effectués par un électricien agréé.
- › Terre protectrice: terre de protection (symbole 7).
- › Tous les luminaires peuvent devenir chauds. Faites preuve de discrétion sur l'endroit où le luminaire est monté. Faites attention lors du réglage du luminaire car il peut devenir chaud.
- › Le luminaire ne doit être utilisé qu'avec un écran protecteur. Si l'écran de protection est fissuré, arrêtez immédiatement d'utiliser le luminaire. Isolez la source de lumière, maintenez-la au sec et contactez immédiatement le fabricant pour remplacer l'écran de protection (symbole 11).
- › Si le câble ou le cordon flexible externe de ce luminaire est endommagé, il doit être remplacé exclusivement par le fabricant, son agent de service ou une personne qualifiée similaire afin d'éviter un danger.
- › La source lumineuse contenue dans ce luminaire ne doit être remplacée que par le fabricant, son agent de service ou une personne qualifiée similaire.
- › Ne regardez pas la source de lumière opératoire. Le luminaire doit être positionné de telle sorte qu'un regard prolongé dans le luminaire à une distance inférieure à 23 pi (7 m) ne soit pas prévu (symbole 13)
- › L'isolation de base a été maintenue entre la tension secteur et les conducteurs de commande.
- › Pour réduire le risque d'étranglement, le câblage flexible connecté à ce luminaire doit être efficacement fixé au mur si le câblage est à portée de main.
- › Assurez-vous que l'alimentation secteur est protégée contre les surtensions.
- › Ne jamais établir ni interrompre les connexions lorsque le circuit est sous tension.
- › N'apportez pas de modifications ou n'altérez pas le produit.
- › Gardez le luminaire propre et exempt de débris.
- › Nettoyez uniquement à l'eau tiède.
- › N'utilisez pas de produits chimiques ou abrasifs pour nettoyer le luminaire car cela pourrait annuler la garantie du produit.
- › Les connexions doivent être maintenues propres et sèches en tout temps.
- › Convient pour une utilisation à l'intérieur ou à l'extérieur.

IT

Si prega di leggere e seguire attentamente tutte le istruzioni di sicurezza. In caso contrario, la garanzia verrà annullata.

**AVVERTENZA - La garanzia del prodotto è nulla se il prodotto non è installato secondo le istruzioni di installazione e in conformità con tutti i codici locali e provinciali.**

- › Assicurarsi che l'installazione sia conforme alle norme e ai regolamenti elettrici locali.
- › Tutti i lavori elettrici devono essere eseguiti da un elettricista autorizzato.
- › Terra protettiva: terra di protezione (simbolo 7).
- › Tutti gli apparecchi possono surriscaldarsi. Usa discrezione su dove la lampada è montata. Fare attenzione quando si posiziona la lampada in quanto potrebbe surriscaldarsi.
- › L'apparecchio deve essere utilizzato solo completo di schermo protettivo. Se lo schermo protettivo è rotto, interrompere immediatamente l'uso dell'apparecchio. Isolare la fonte di luce, mantenerla asciutta e contattare immediatamente il produttore per la sostituzione dello schermo protettivo (simbolo 11).
- › Se il cavo flessibile esterno o il cavo di questo apparecchio di illuminazione è danneggiato, deve essere sostituito esclusivamente dal produttore, dal suo agente di servizio o da una persona qualificata simile al fine di evitare rischi.
- › La sorgente luminosa contenuta in questo apparecchio di illuminazione deve essere sostituita solo dal produttore, dal suo agente di servizio o da una persona qualificata simile.
- › Non fissare la sorgente di luce operativa. L'apparecchio di illuminazione deve essere posizionato in modo che non sia previsto uno sguardo prolungato nell'apparecchio di illuminazione a una distanza inferiore a 23' (7 m) (simbolo 13)
- › L'isolamento di base è stato mantenuto tra la tensione di linea e i conduttori di controllo.
- › Per ridurre il rischio di strangolamento, il cablaggio flessibile collegato a questo apparecchio di illuminazione deve essere efficacemente fissato alla parete se il cablaggio è a portata di mano.
- › Assicurarsi che l'alimentazione di rete sia protetta da sovratensioni.
- › Non effettuare o interrompere mai i collegamenti mentre il circuito è sotto tensione.
- › Non apportare modifiche o alterare il prodotto.
- › Mantenere la lampada pulita e priva di detriti.
- › Pulisci solo con acqua tiepida.
- › Non utilizzare prodotti chimici o abrasivi per pulire la lampada in quanto ciò potrebbe invalidare la garanzia del prodotto.
- › Le connessioni devono essere mantenute sempre pulite e asciutte.
- › Adatto per uso interno o esterno.

GE

Bitte lesen und befolgen Sie alle Sicherheitshinweise sorgfältig. Andernfalls erlischt die Garantie.

**WARNUNG - Die Produktgarantie erlischt, wenn das Produkt nicht gemäß den Installationsanweisungen und in Übereinstimmung mit allen örtlichen und regionalen Vorschriften installiert wird.**

- › Stellen Sie sicher, dass die Installation den örtlichen elektrischen Vorschriften und Bestimmungen entspricht.
- › Alle elektrischen Arbeiten müssen von einem zugelassenen Elektriker ausgeführt werden.
- › Beschützende Erde: Schutzgrund (Symbol 7).
- › Alle Leuchten können heiß werden. Verwenden Sie Diskretion, wo die Leuchte montiert. Seien Sie vorsichtig beim Einstellen der Leuchte, da diese heiß werden kann.
- › Die Leuchte sollte nur komplett mit Schutzhild verwendet werden. Wenn der Schutzhild Risse aufweist, verwenden Sie die Leuchte sofort nicht mehr. Isolieren Sie die Lichtquelle, halten Sie sie trocken und wenden Sie sich sofort an den Hersteller, um den Schutzhild auszutauschen (Symbol 11).
- › Wenn das externe flexible Kabel oder Kabel dieser Leuchte beschädigt ist, muss es ausschließlich vom Hersteller, seinem Servicemitarbeiter oder einer ähnlich qualifizierten Person ausgetauscht werden, um eine Gefahr zu vermeiden.
- › Die in dieser Leuchte enthaltene Lichtquelle darf nur vom Hersteller, seinem Servicemitarbeiter oder einer ähnlich qualifizierten Person ersetzt werden.
- › Starren Sie nicht auf die Operationslichtquelle. Die Leuchte sollte so positioniert werden, dass ein längerer Blick in die Leuchte in einem Abstand von weniger als 7 m nicht zu erwarten ist (Symbol 13).
- › Die Grundisolation zwischen der Netzspannung und den Steuerleitern wurde beibehalten.
- › Um das Risiko einer Strangulation zu verringern, muss die an diese Leuchte angeschlossene flexible Verkabelung effektiv an der Wand befestigt werden, wenn sich die Verkabelung in Reichweite des Arms befindet.
- › Stellen Sie sicher, dass die Netzspannung überspannungsgeschützt ist.
- › Stellen Sie niemals Verbindungen her oder unterbrechen Sie diese, während der Stromkreis unter Spannung steht.
- › Nehmen Sie keine Änderungen vor oder verändern Sie das Produkt.
- › Halten Sie die Leuchte sauber und frei von Schmutz.
- › Nur mit warmem Wasser reinigen.
- › Verwenden Sie zum Reinigen der Leuchte keine Chemikalien oder Schleifmittel, da dadurch die Produktgarantie erlöschen kann.
- › Die Anschlüsse sind stets sauber und trocken zu halten.
- › Geeignet für den Innen- und Außenbereich.

DK

Læs og følg alle sikkerhedsinstruktioner nøje. Hvis dette ikke gøres, bortfalder garantien.

**ADVARSEL - Produktgaranti er ugyldig, hvis produktet ikke er installeret i henhold til installationsinstruktionerne og i overensstemmelse med alle lokale og provinsielle koder.**

- › Sørg for, at installationen overholder lokale elektriske regler og forskrifter.
- › Alt elektrisk arbejde skal udføres af en autoriseret elektriker.
- › Beskyttende jord; beskyttelsesgrund (symbol 7).
- › Alle armaturer kan blive varme. Brug skøn over, hvor armaturet er monteret. Vær forsigtig, når du indstiller armaturet, da det kan blive varmt.
- › Armaturet bør kun bruges komplet med beskyttelsesafskærmning. Hvis beskyttelsesafskærmningen er revnet, skal du straks stoppe med at bruge armaturet. Isolér lyskilden, hold den tør og kontakt straks producenten for at udskifte beskyttelses-skærmen (symbol 11).
- › Hvis det eksterne fleksible kabel eller ledningen til dette armatur er beskadiget, skal det udelukkende udskiftes af producenten, deres serviceagent eller en lignende kvalificeret person for at undgå en fare.
- › Lyskilden i dette armatur må kun udskiftes af producenten, deres serviceagent eller en lignende kvalificeret person.
- › Stir ikke på driftslyskilden. Armaturet skal placeres, så der ikke forventes langvarig stiring ind i armaturet i en afstand nærmere end 23' (7 m) (symbol 13)
- › Grundlæggende isolering er opretholdt mellem netspænding og styreledere.
- › For at reducere risikoen for strangulering skal de fleksible ledninger, der er forbundet med denne armatur, være effektivt fastgjort til væggen, hvis ledningerne er inden for armens rækkevidde.
- › Sørg for, at strømforsyningen er overspændingsbeskyttet.
- › Opret eller afbryd aldrig forbindelser, mens kredsløbet er strømforsynet. Foretag ikke ændringer eller modificer produktet.
- › Hold armaturet rent og fri for snavs.
- › Rengør kun med varmt vand.
- › Brug ikke kemikalier eller slibemidler til at rengøre armaturet, da dette kan annullere produktgarantien.
- › Forbindelser skal til enhver tid holdes rene og tørre.
- › Velegnet til brug indendørs eller udendørs.

ES

Lea y siga todas las instrucciones de seguridad con atención. No hacerlo anulará la garantía.

**ADVERTENCIA: la garantía del producto es nula si el producto no se instala según las instrucciones de instalación y de conformidad con todos los códigos locales y provinciales.**

- › Asegúrese de que la instalación cumpla con las normas y regulaciones eléctricas locales.
- › Todo el trabajo eléctrico debe ser realizado por un electricista autorizado.
- › Tierra de protección; tierra de protección (símbolo 7).
- › Todas las luminarias pueden calentarse. Use la discreción sobre dónde está la luminaria esta montado. Tenga cuidado al colocar la luminaria ya que puede calentarse.
- › La luminaria solo debe usarse completa con pantalla protectora. Si el escudo protector está agrietado, deje de usar la luminaria inmediatamente. Aísle la fuente de luz, manténgala seca y comuníquese inmediatamente con el fabricante para el reemplazo de la pantalla protectora (símbolo 11).
- › Si el cable flexible externo o el cordón de esta luminaria está dañado, deberá ser reemplazado exclusivamente por el fabricante, su agente de servicio o una persona calificada similar para evitar un peligro.
- › La fuente de luz contenida en esta luminaria solo debe ser reemplazada por el fabricante, su agente de servicio o una persona calificada similar.
- › No mire fijamente la fuente de luz operativa. La luminaria debe colocarse de manera que no se espere una mirada prolongada a la luminaria a una distancia menor a 23' (7 m) (símbolo 13)
- › Se ha mantenido el aislamiento básico entre el voltaje de línea y los conductores de control.
- › Para reducir el riesgo de estrangulamiento, el cableado flexible conectado a esta luminaria se fijará eficazmente a la pared si el cableado está al alcance de la mano.
- › Asegúrese de que la alimentación de entrada de la red esté protegida contra sobretensiones.
- › Nunca haga o rompa conexiones mientras el circuito está energizado.
- › No realice modificaciones ni altere el producto.
- › Mantenga la luminaria limpia y libre de escombros.
- › Limpiar solo con agua tibia.
- › No utilice productos químicos o abrasivos para limpiar la luminaria, ya que esto puede anular la garantía del producto.
- › Las conexiones deben mantenerse limpias y secas en todo momento.
- › Apto para uso en interiores o exteriores.

# ERDEN E4 LS3042 Foundation

Direct Burial

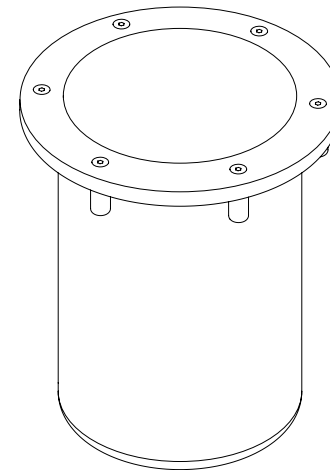

|                            |  |
|----------------------------|--|
| <b>MODEL</b>               | LS3042   |
| <b>PART NUMBER</b>         | LS3042 – 18D xxx x x xx xx 21 x 01 xx<br>LS3042 – 18D xxx x x xx xx 21 x 09 xx |
| <b>INSTALLATION TYPE</b>   | INGROUND/IN-GRADE (Direct Burial)  |
| <b>IP RATING</b>           | IP66/67 (Passes IP68 Test)   |
| <b>SUPPLY VOLTAGE</b>      | 220-240 ~Vac, 50 Hz<br>120/277 ~Vac, 60 Hz                                     |
| <b>INSTRUCTIONS COVER</b>  | Single Color (Non-Dimmable)<br>Single Color Dimming (Dali, 0-10 V)             |
| <b>DIMENSIONS (LxWxH)</b>  | 8.3" x 8.7" (210 x 220 mm)   |
| <b>WEIGHT</b>              | 8.8 lbs (4.0 kg)   |
| <b>SURFACE TEMPERATURE</b> | < 149 °F (65 °C)   |
| <b>STATIC LOAD RATING</b>  | 3,968 lbs (1,800 kg)   |



## Tools Required

Outils nécessaires | Strumenti richiesti | Werkzeuge benötigt | Nødvendigt værktøj | Herramientas necesarias

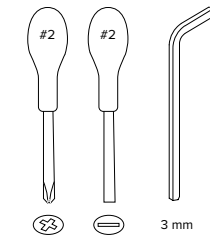

## Included Components

Composants inclus | Componenti inclusi | Enthaltene Komponenten | Inkluderede komponenter | Componentes incluidos

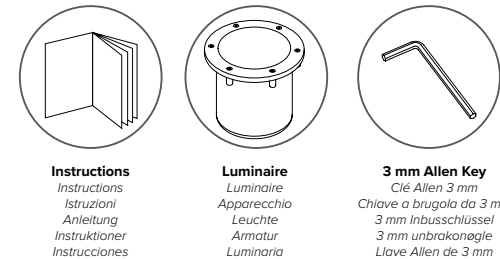

**Instructions**  
Instructions  
Istruzioni  
Anleitung  
Instruktioner  
Instrucciones

**Luminaire**  
Luminaire  
Apparecchio  
Leuchte  
Armatur  
Luminaria

**3 mm Allen Key**  
Clé Allen 3 mm  
Clave a brugola da 3 mm  
3 mm Inbusschlüssel  
3 mm unbrakonøgle  
Llave Allen de 3 mm

## Optional Accessories

Accessoires optionnels | Accessori Opzionali | Optionales Zubehör | Valgfritt tilbehør | Accesorios Opcionales

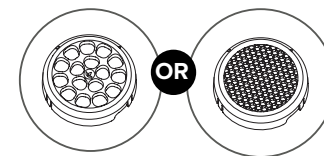

**Louver (Optional)**  
Persienne (En option)  
Persienne (En option)  
Jalousie (optional)  
Louver (valgfri)  
Louver (opcional)

**Do Not Use Power Tools on Screws**  
N'utilisez pas d'outils électriques pour les vis  
Non utilizzare utensili elettrici sulle viti  
Verwenden Sie keine Elektrowerkzeuge für Schrauben  
Brug ikke elværktøj på skruer  
No use herramientas eléctricas en los tornillos

**Keep Electronics Free From Dirt and Moisture**  
Protégez l'électronique de la saleté et de l'humidité  
Tenere i componenti elettronici liberi da sporco e umidità  
Halten Sie die Elektronik frei von Schmutz und Feuchtigkeit  
Hold elektronik fri for snavs og fugt  
Mantenga los dispositivos electrónicos libres de suciedad y humedad

**No Downward Force**  
Pas de force descendante  
Nessuna forza verso il basso  
Keine Abwärtskraft  
Ingen nedadgående kraft  
Sin fuerza descendente

**Keep Away from Flammable Materials**  
Tenir à l'écart des matériaux inflammables  
Tenere lontano da materiali infiammabili  
Von brennbaren Materialien fernhalten  
Holdes væk fra brandfarlige materialer  
Manténgase alejado de materiales inflamables

**Do Not Hose or Pressure Clean**  
Ne pas arroser ou Nettoyer à pression  
Non usare il tubo o Pulizia a pressione  
Nicht abspritzen oder Druckreinigung  
Må ikke slange eller Tryk ren  
No lave ni Limpieza a presión

**Do Not Overtighten**  
Ne pas trop serrer  
Non stringere eccessivamente  
Nicht überdrehen  
No apriete demasiado

**Do Not Use Silicone On Outside Surface**  
N'utilisez pas de silicone sur la surface extérieure  
Non utilizzare silicone sulla superficie esterna  
Verwenden Sie kein Silikon an der Außenfläche  
Brug ikke silikone på ydersiden  
No use silicona en la superficie exterior

**Do Not Cut Cable to the Luminaire**  
Ne coupez pas le câble du luminaire  
Non tagliare il cavo all'apparecchio  
Schneiden Sie kein Kabel zur Leuchte ab  
Klip ikke kablet til armaturet  
No corte el cable a la luminaria

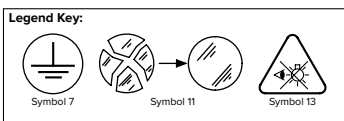

## Assembly Instructions

Instructions de montage | Istruzioni di montaggio | Montageanleitungen | Monteringsvejledning | Instrucciones de montaje

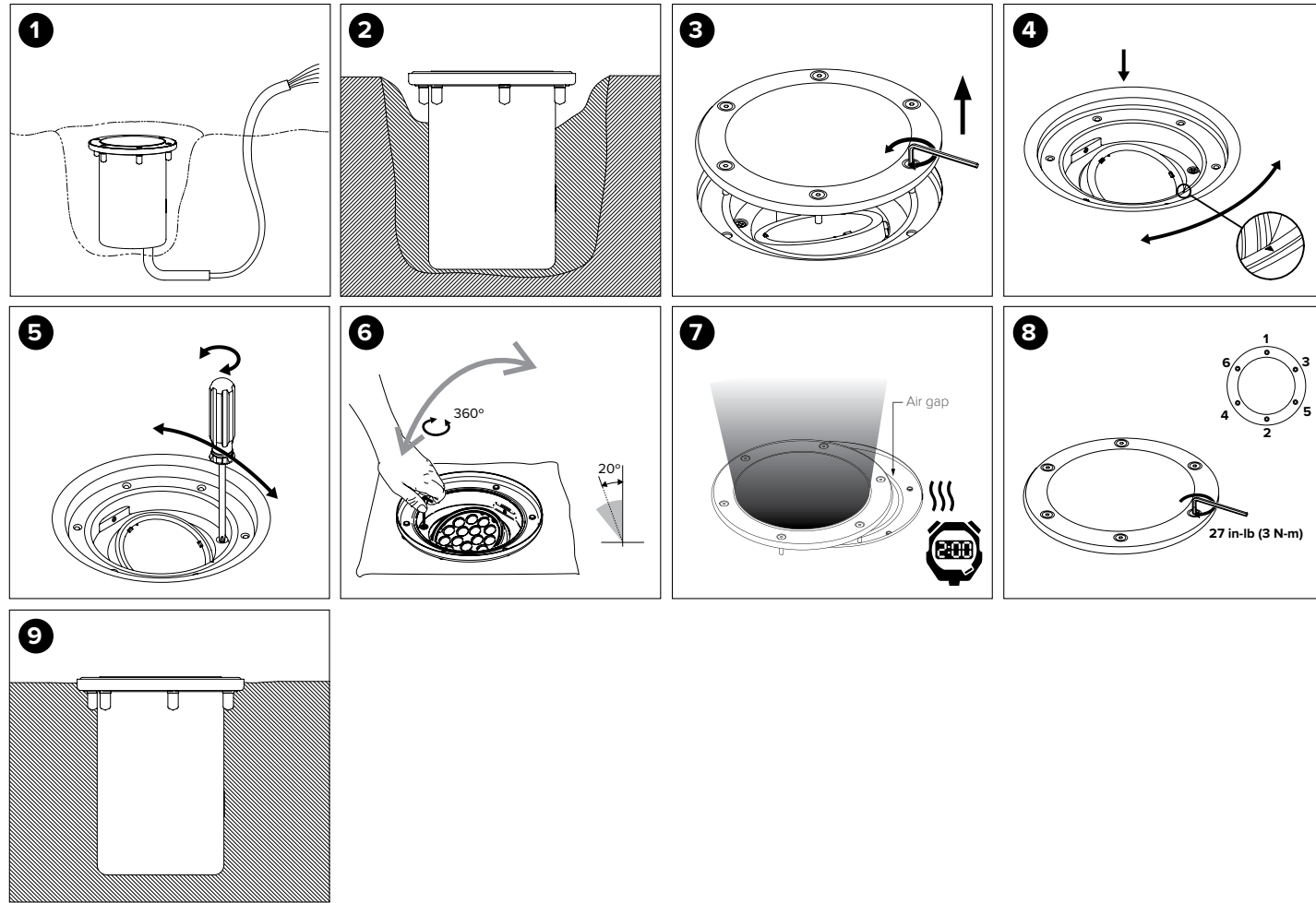

## Optional Glare Control Accessories

Accessoires de contrôle de l'éblouissement en option | Accessori opzionali per il controllo dell'abbagliamento | Optionales Blendschutzzubehör | Valgfritt tilbehør til blændingskontrol | Accesorios opcionales para el control del deslumbramiento

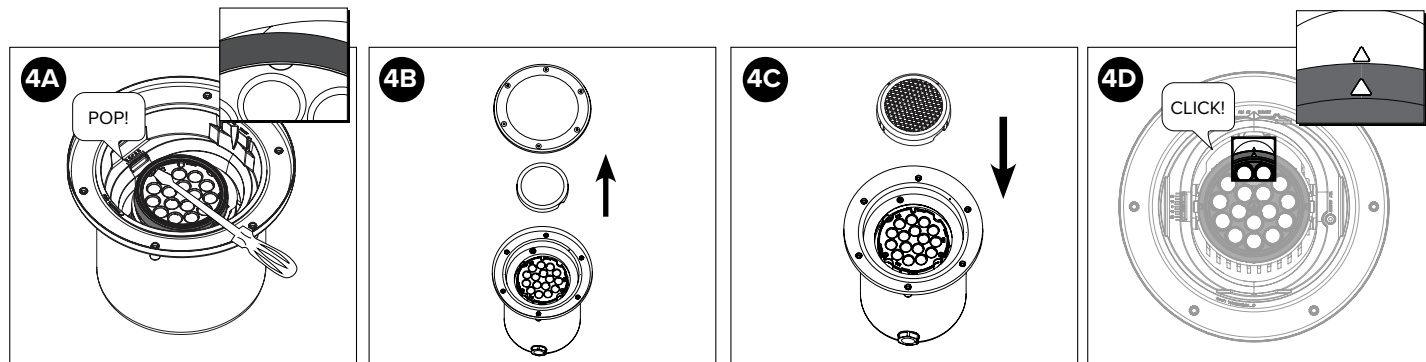

Please recycle the aluminum trim according to Local Government Guidelines.  
 Veuillez recycler la garniture en aluminium conformément aux directives du gouvernement local.  
 Si prega di riciclare il rivestimento in alluminio secondo le linee guida del governo locale.  
 Bitte recyceln Sie die Aluminiumverkleidung gemäß den Richtlinien der lokalen Regierung.  
 Genbrug aluminiumsbeklædningen i henhold til lokale myndigheders retningslinjer.  
 Recicle la moldura de aluminio de acuerdo con las pautas del gobierno local.

## Wiring Designations

Désignations de câblage | Designazioni cablaggio | Verdrahtungsbezeichnungen | Ledningsbetegnelser | Designaciones de cableado

### Non-Dimmable (3-Core) – International

| EN  | FR               | IT    | DE     | DA    | ES      |      |       |                |   |                |         |       |        |        |      |       |              |  |              |        |        |         |        |     |       |              |   |             |       |       |       |         |      |      |           |  |            |       |        |       |        |      |          |        |   |             |       |        |        |         |      |        |                  |
|---|------------------|-------|--------|-------|---------|------|-------|----------------|---|----------------|---------|-------|--------|--------|------|-------|--------------|--|--------------|--------|--------|---------|--------|-----|-------|--------------|---|-------------|-------|-------|-------|---------|------|------|-----------|--|------------|-------|--------|-------|--------|------|----------|--------|---|-------------|-------|--------|--------|---------|------|--------|------------------|
| <table border="1"> <thead> <tr> <th>Designation</th> <th>Color</th> </tr> </thead> <tbody> <tr> <td>Active</td> <td>Brown</td> </tr> <tr> <td>Neutral</td> <td>Blue</td> </tr> <tr> <td>Earth</td> <td>Green / Yellow</td> </tr> </tbody> </table> <p><i>Do not Hi-Pot test</i></p> | Designation      | Color | Active | Brown | Neutral | Blue | Earth | Green / Yellow | <table border="1"> <thead> <tr> <th>La désignation</th> <th>Couleur</th> </tr> </thead> <tbody> <tr> <td>Actif</td> <td>Marron</td> </tr> <tr> <td>Neutre</td> <td>Bleu</td> </tr> <tr> <td>Terre</td> <td>Vert / Jaune</td> </tr> </tbody> </table> <p><i>Ne pas tester Hi-Pot</i></p> | La désignation | Couleur | Actif | Marron | Neutre | Bleu | Terre | Vert / Jaune | <table border="1"> <thead> <tr> <th>Designazione</th> <th>Colore</th> </tr> </thead> <tbody> <tr> <td>Attivo</td> <td>Marrone</td> </tr> <tr> <td>Neutro</td> <td>Blu</td> </tr> <tr> <td>Terra</td> <td>Verde/Giallo</td> </tr> </tbody> </table> <p><i>Non eseguire il test Hi-Pot</i></p> | Designazione | Colore | Attivo | Marrone | Neutro | Blu | Terra | Verde/Giallo | <table border="1"> <thead> <tr> <th>Bezeichnung</th> <th>Farbe</th> </tr> </thead> <tbody> <tr> <td>Aktiv</td> <td>Braun</td> </tr> <tr> <td>Neutral</td> <td>Blau</td> </tr> <tr> <td>Erde</td> <td>Grün Gelb</td> </tr> </tbody> </table> <p><i>Hi-Pot-Test nicht durchführen</i></p> | Bezeichnung | Farbe | Aktiv | Braun | Neutral | Blau | Erde | Grün Gelb | <table border="1"> <thead> <tr> <th>Aanwijzing</th> <th>Kleur</th> </tr> </thead> <tbody> <tr> <td>Actief</td> <td>Bruin</td> </tr> <tr> <td>Neutre</td> <td>Bleu</td> </tr> <tr> <td>Neutrale</td> <td>Blaauw</td> </tr> </tbody> </table> <p><i>Test ikke Hi-Pot</i></p> | Aanwijzing | Kleur | Actief | Bruin | Neutre | Bleu | Neutrale | Blaauw | <table border="1"> <thead> <tr> <th>Designacion</th> <th>Color</th> </tr> </thead> <tbody> <tr> <td>Activo</td> <td>Marrón</td> </tr> <tr> <td>Neutral</td> <td>Azul</td> </tr> <tr> <td>Tierra</td> <td>Verde / Amarilla</td> </tr> </tbody> </table> <p><i>No pruebe Hi-Pot</i></p> | Designacion | Color | Activo | Marrón | Neutral | Azul | Tierra | Verde / Amarilla |
| Designation   | Color            |       |        |       |         |      |       |                |   |                |         |       |        |        |      |       |              |  |              |        |        |         |        |     |       |              |   |             |       |       |       |         |      |      |           |  |            |       |        |       |        |      |          |        |   |             |       |        |        |         |      |        |                  |
| Active  | Brown            |       |        |       |         |      |       |                |   |                |         |       |        |        |      |       |              |  |              |        |        |         |        |     |       |              |   |             |       |       |       |         |      |      |           |  |            |       |        |       |        |      |          |        |   |             |       |        |        |         |      |        |                  |
| Neutral   | Blue             |       |        |       |         |      |       |                |   |                |         |       |        |        |      |       |              |  |              |        |        |         |        |     |       |              |   |             |       |       |       |         |      |      |           |  |            |       |        |       |        |      |          |        |   |             |       |        |        |         |      |        |                  |
| Earth   | Green / Yellow   |       |        |       |         |      |       |                |   |                |         |       |        |        |      |       |              |  |              |        |        |         |        |     |       |              |   |             |       |       |       |         |      |      |           |  |            |       |        |       |        |      |          |        |   |             |       |        |        |         |      |        |                  |
| La désignation  | Couleur          |       |        |       |         |      |       |                |   |                |         |       |        |        |      |       |              |  |              |        |        |         |        |     |       |              |   |             |       |       |       |         |      |      |           |  |            |       |        |       |        |      |          |        |   |             |       |        |        |         |      |        |                  |
| Actif   | Marron           |       |        |       |         |      |       |                |   |                |         |       |        |        |      |       |              |  |              |        |        |         |        |     |       |              |   |             |       |       |       |         |      |      |           |  |            |       |        |       |        |      |          |        |   |             |       |        |        |         |      |        |                  |
| Neutre  | Bleu             |       |        |       |         |      |       |                |   |                |         |       |        |        |      |       |              |  |              |        |        |         |        |     |       |              |   |             |       |       |       |         |      |      |           |  |            |       |        |       |        |      |          |        |   |             |       |        |        |         |      |        |                  |
| Terre   | Vert / Jaune     |       |        |       |         |      |       |                |   |                |         |       |        |        |      |       |              |  |              |        |        |         |        |     |       |              |   |             |       |       |       |         |      |      |           |  |            |       |        |       |        |      |          |        |   |             |       |        |        |         |      |        |                  |
| Designazione  | Colore           |       |        |       |         |      |       |                |   |                |         |       |        |        |      |       |              |  |              |        |        |         |        |     |       |              |   |             |       |       |       |         |      |      |           |  |            |       |        |       |        |      |          |        |   |             |       |        |        |         |      |        |                  |
| Attivo  | Marrone          |       |        |       |         |      |       |                |   |                |         |       |        |        |      |       |              |  |              |        |        |         |        |     |       |              |   |             |       |       |       |         |      |      |           |  |            |       |        |       |        |      |          |        |   |             |       |        |        |         |      |        |                  |
| Neutro  | Blu              |       |        |       |         |      |       |                |   |                |         |       |        |        |      |       |              |  |              |        |        |         |        |     |       |              |   |             |       |       |       |         |      |      |           |  |            |       |        |       |        |      |          |        |   |             |       |        |        |         |      |        |                  |
| Terra   | Verde/Giallo     |       |        |       |         |      |       |                |   |                |         |       |        |        |      |       |              |  |              |        |        |         |        |     |       |              |   |             |       |       |       |         |      |      |           |  |            |       |        |       |        |      |          |        |   |             |       |        |        |         |      |        |                  |
| Bezeichnung   | Farbe            |       |        |       |         |      |       |                |   |                |         |       |        |        |      |       |              |  |              |        |        |         |        |     |       |              |   |             |       |       |       |         |      |      |           |  |            |       |        |       |        |      |          |        |   |             |       |        |        |         |      |        |                  |
| Aktiv   | Braun            |       |        |       |         |      |       |                |   |                |         |       |        |        |      |       |              |  |              |        |        |         |        |     |       |              |   |             |       |       |       |         |      |      |           |  |            |       |        |       |        |      |          |        |   |             |       |        |        |         |      |        |                  |
| Neutral   | Blau             |       |        |       |         |      |       |                |   |                |         |       |        |        |      |       |              |  |              |        |        |         |        |     |       |              |   |             |       |       |       |         |      |      |           |  |            |       |        |       |        |      |          |        |   |             |       |        |        |         |      |        |                  |
| Erde  | Grün Gelb        |       |        |       |         |      |       |                |   |                |         |       |        |        |      |       |              |  |              |        |        |         |        |     |       |              |   |             |       |       |       |         |      |      |           |  |            |       |        |       |        |      |          |        |   |             |       |        |        |         |      |        |                  |
| Aanwijzing  | Kleur            |       |        |       |         |      |       |                |   |                |         |       |        |        |      |       |              |  |              |        |        |         |        |     |       |              |   |             |       |       |       |         |      |      |           |  |            |       |        |       |        |      |          |        |   |             |       |        |        |         |      |        |                  |
| Actief  | Bruin            |       |        |       |         |      |       |                |   |                |         |       |        |        |      |       |              |  |              |        |        |         |        |     |       |              |   |             |       |       |       |         |      |      |           |  |            |       |        |       |        |      |          |        |   |             |       |        |        |         |      |        |                  |
| Neutre  | Bleu             |       |        |       |         |      |       |                |   |                |         |       |        |        |      |       |              |  |              |        |        |         |        |     |       |              |   |             |       |       |       |         |      |      |           |  |            |       |        |       |        |      |          |        |   |             |       |        |        |         |      |        |                  |
| Neutrale  | Blaauw           |       |        |       |         |      |       |                |   |                |         |       |        |        |      |       |              |  |              |        |        |         |        |     |       |              |   |             |       |       |       |         |      |      |           |  |            |       |        |       |        |      |          |        |   |             |       |        |        |         |      |        |                  |
| Designacion   | Color            |       |        |       |         |      |       |                |   |                |         |       |        |        |      |       |              |  |              |        |        |         |        |     |       |              |   |             |       |       |       |         |      |      |           |  |            |       |        |       |        |      |          |        |   |             |       |        |        |         |      |        |                  |
| Activo  | Marrón           |       |        |       |         |      |       |                |   |                |         |       |        |        |      |       |              |  |              |        |        |         |        |     |       |              |   |             |       |       |       |         |      |      |           |  |            |       |        |       |        |      |          |        |   |             |       |        |        |         |      |        |                  |
| Neutral   | Azul             |       |        |       |         |      |       |                |   |                |         |       |        |        |      |       |              |  |              |        |        |         |        |     |       |              |   |             |       |       |       |         |      |      |           |  |            |       |        |       |        |      |          |        |   |             |       |        |        |         |      |        |                  |
| Tierra  | Verde / Amarilla |       |        |       |         |      |       |                |   |                |         |       |        |        |      |       |              |  |              |        |        |         |        |     |       |              |   |             |       |       |       |         |      |      |           |  |            |       |        |       |        |      |          |        |   |             |       |        |        |         |      |        |                  |

### DALI (5-Core) – International

| EN   | FR               | IT    | DE     | DA    | ES      |      |       |                |        |      |        |       |   |                |         |       |        |        |      |       |              |        |      |        |      |  |              |        |        |         |        |     |       |              |        |        |        |      |  |             |       |       |       |         |      |      |           |        |         |        |      |   |            |       |        |       |        |      |          |        |        |     |        |      |  |             |       |        |        |         |      |        |                  |        |      |        |       |
|--|------------------|-------|--------|-------|---------|------|-------|----------------|--------|------|--------|-------|---|----------------|---------|-------|--------|--------|------|-------|--------------|--------|------|--------|------|--|--------------|--------|--------|---------|--------|-----|-------|--------------|--------|--------|--------|------|--|-------------|-------|-------|-------|---------|------|------|-----------|--------|---------|--------|------|---|------------|-------|--------|-------|--------|------|----------|--------|--------|-----|--------|------|--|-------------|-------|--------|--------|---------|------|--------|------------------|--------|------|--------|-------|
| <table border="1"> <thead> <tr> <th>Designation</th> <th>Color</th> </tr> </thead> <tbody> <tr> <td>Active</td> <td>Brown</td> </tr> <tr> <td>Neutral</td> <td>Blue</td> </tr> <tr> <td>Earth</td> <td>Green / Yellow</td> </tr> <tr> <td>DALI +</td> <td>Grey</td> </tr> <tr> <td>DALI -</td> <td>Black</td> </tr> </tbody> </table> <p><i>Do not Hi-Pot test</i></p> | Designation      | Color | Active | Brown | Neutral | Blue | Earth | Green / Yellow | DALI + | Grey | DALI - | Black | <table border="1"> <thead> <tr> <th>La désignation</th> <th>Couleur</th> </tr> </thead> <tbody> <tr> <td>Actif</td> <td>Marron</td> </tr> <tr> <td>Neutre</td> <td>Bleu</td> </tr> <tr> <td>Terre</td> <td>Vert / Jaune</td> </tr> <tr> <td>DALI +</td> <td>Gris</td> </tr> <tr> <td>DALI -</td> <td>Noir</td> </tr> </tbody> </table> <p><i>Ne pas tester Hi-Pot</i></p> | La désignation | Couleur | Actif | Marron | Neutre | Bleu | Terre | Vert / Jaune | DALI + | Gris | DALI - | Noir | <table border="1"> <thead> <tr> <th>Designazione</th> <th>Colore</th> </tr> </thead> <tbody> <tr> <td>Attivo</td> <td>Marrone</td> </tr> <tr> <td>Neutro</td> <td>Blu</td> </tr> <tr> <td>Terra</td> <td>Verde/Giallo</td> </tr> <tr> <td>DALI +</td> <td>Grigio</td> </tr> <tr> <td>DALI -</td> <td>Nero</td> </tr> </tbody> </table> <p><i>Non eseguire il test Hi-Pot</i></p> | Designazione | Colore | Attivo | Marrone | Neutro | Blu | Terra | Verde/Giallo | DALI + | Grigio | DALI - | Nero | <table border="1"> <thead> <tr> <th>Bezeichnung</th> <th>Farbe</th> </tr> </thead> <tbody> <tr> <td>Aktiv</td> <td>Braun</td> </tr> <tr> <td>Neutral</td> <td>Blau</td> </tr> <tr> <td>Erde</td> <td>Grün Gelb</td> </tr> <tr> <td>DALI +</td> <td>Schwarz</td> </tr> <tr> <td>DALI -</td> <td>Grau</td> </tr> </tbody> </table> <p><i>Hi-Pot-Test nicht durchführen</i></p> | Bezeichnung | Farbe | Aktiv | Braun | Neutral | Blau | Erde | Grün Gelb | DALI + | Schwarz | DALI - | Grau | <table border="1"> <thead> <tr> <th>Aanwijzing</th> <th>Kleur</th> </tr> </thead> <tbody> <tr> <td>Actief</td> <td>Bruin</td> </tr> <tr> <td>Neutre</td> <td>Bleu</td> </tr> <tr> <td>Neutrale</td> <td>Blaauw</td> </tr> <tr> <td>DALI +</td> <td>Grå</td> </tr> <tr> <td>DALI -</td> <td>Sort</td> </tr> </tbody> </table> <p><i>Test ikke Hi-Pot</i></p> | Aanwijzing | Kleur | Actief | Bruin | Neutre | Bleu | Neutrale | Blaauw | DALI + | Grå | DALI - | Sort | <table border="1"> <thead> <tr> <th>Designacion</th> <th>Color</th> </tr> </thead> <tbody> <tr> <td>Activo</td> <td>Marrón</td> </tr> <tr> <td>Neutral</td> <td>Azul</td> </tr> <tr> <td>Tierra</td> <td>Verde / Amarilla</td> </tr> <tr> <td>DALI +</td> <td>Gris</td> </tr> <tr> <td>DALI -</td> <td>Negro</td> </tr> </tbody> </table> <p><i>No pruebe Hi-Pot</i></p> | Designacion | Color | Activo | Marrón | Neutral | Azul | Tierra | Verde / Amarilla | DALI + | Gris | DALI - | Negro |
| Designation  | Color            |       |        |       |         |      |       |                |        |      |        |       |   |                |         |       |        |        |      |       |              |        |      |        |      |  |              |        |        |         |        |     |       |              |        |        |        |      |  |             |       |       |       |         |      |      |           |        |         |        |      |   |            |       |        |       |        |      |          |        |        |     |        |      |  |             |       |        |        |         |      |        |                  |        |      |        |       |
| Active   | Brown            |       |        |       |         |      |       |                |        |      |        |       |   |                |         |       |        |        |      |       |              |        |      |        |      |  |              |        |        |         |        |     |       |              |        |        |        |      |  |             |       |       |       |         |      |      |           |        |         |        |      |   |            |       |        |       |        |      |          |        |        |     |        |      |  |             |       |        |        |         |      |        |                  |        |      |        |       |
| Neutral  | Blue             |       |        |       |         |      |       |                |        |      |        |       |   |                |         |       |        |        |      |       |              |        |      |        |      |  |              |        |        |         |        |     |       |              |        |        |        |      |  |             |       |       |       |         |      |      |           |        |         |        |      |   |            |       |        |       |        |      |          |        |        |     |        |      |  |             |       |        |        |         |      |        |                  |        |      |        |       |
| Earth  | Green / Yellow   |       |        |       |         |      |       |                |        |      |        |       |   |                |         |       |        |        |      |       |              |        |      |        |      |  |              |        |        |         |        |     |       |              |        |        |        |      |  |             |       |       |       |         |      |      |           |        |         |        |      |   |            |       |        |       |        |      |          |        |        |     |        |      |  |             |       |        |        |         |      |        |                  |        |      |        |       |
| DALI +   | Grey             |       |        |       |         |      |       |                |        |      |        |       |   |                |         |       |        |        |      |       |              |        |      |        |      |  |              |        |        |         |        |     |       |              |        |        |        |      |  |             |       |       |       |         |      |      |           |        |         |        |      |   |            |       |        |       |        |      |          |        |        |     |        |      |  |             |       |        |        |         |      |        |                  |        |      |        |       |
| DALI -   | Black            |       |        |       |         |      |       |                |        |      |        |       |   |                |         |       |        |        |      |       |              |        |      |        |      |  |              |        |        |         |        |     |       |              |        |        |        |      |  |             |       |       |       |         |      |      |           |        |         |        |      |   |            |       |        |       |        |      |          |        |        |     |        |      |  |             |       |        |        |         |      |        |                  |        |      |        |       |
| La désignation   | Couleur          |       |        |       |         |      |       |                |        |      |        |       |   |                |         |       |        |        |      |       |              |        |      |        |      |  |              |        |        |         |        |     |       |              |        |        |        |      |  |             |       |       |       |         |      |      |           |        |         |        |      |   |            |       |        |       |        |      |          |        |        |     |        |      |  |             |       |        |        |         |      |        |                  |        |      |        |       |
| Actif  | Marron           |       |        |       |         |      |       |                |        |      |        |       |   |                |         |       |        |        |      |       |              |        |      |        |      |  |              |        |        |         |        |     |       |              |        |        |        |      |  |             |       |       |       |         |      |      |           |        |         |        |      |   |            |       |        |       |        |      |          |        |        |     |        |      |  |             |       |        |        |         |      |        |                  |        |      |        |       |
| Neutre   | Bleu             |       |        |       |         |      |       |                |        |      |        |       |   |                |         |       |        |        |      |       |              |        |      |        |      |  |              |        |        |         |        |     |       |              |        |        |        |      |  |             |       |       |       |         |      |      |           |        |         |        |      |   |            |       |        |       |        |      |          |        |        |     |        |      |  |             |       |        |        |         |      |        |                  |        |      |        |       |
| Terre  | Vert / Jaune     |       |        |       |         |      |       |                |        |      |        |       |   |                |         |       |        |        |      |       |              |        |      |        |      |  |              |        |        |         |        |     |       |              |        |        |        |      |  |             |       |       |       |         |      |      |           |        |         |        |      |   |            |       |        |       |        |      |          |        |        |     |        |      |  |             |       |        |        |         |      |        |                  |        |      |        |       |
| DALI +   | Gris             |       |        |       |         |      |       |                |        |      |        |       |   |                |         |       |        |        |      |       |              |        |      |        |      |  |              |        |        |         |        |     |       |              |        |        |        |      |  |             |       |       |       |         |      |      |           |        |         |        |      |   |            |       |        |       |        |      |          |        |        |     |        |      |  |             |       |        |        |         |      |        |                  |        |      |        |       |
| DALI -   | Noir             |       |        |       |         |      |       |                |        |      |        |       |   |                |         |       |        |        |      |       |              |        |      |        |      |  |              |        |        |         |        |     |       |              |        |        |        |      |  |             |       |       |       |         |      |      |           |        |         |        |      |   |            |       |        |       |        |      |          |        |        |     |        |      |  |             |       |        |        |         |      |        |                  |        |      |        |       |
| Designazione   | Colore           |       |        |       |         |      |       |                |        |      |        |       |   |                |         |       |        |        |      |       |              |        |      |        |      |  |              |        |        |         |        |     |       |              |        |        |        |      |  |             |       |       |       |         |      |      |           |        |         |        |      |   |            |       |        |       |        |      |          |        |        |     |        |      |  |             |       |        |        |         |      |        |                  |        |      |        |       |
| Attivo   | Marrone          |       |        |       |         |      |       |                |        |      |        |       |   |                |         |       |        |        |      |       |              |        |      |        |      |  |              |        |        |         |        |     |       |              |        |        |        |      |  |             |       |       |       |         |      |      |           |        |         |        |      |   |            |       |        |       |        |      |          |        |        |     |        |      |  |             |       |        |        |         |      |        |                  |        |      |        |       |
| Neutro   | Blu              |       |        |       |         |      |       |                |        |      |        |       |   |                |         |       |        |        |      |       |              |        |      |        |      |  |              |        |        |         |        |     |       |              |        |        |        |      |  |             |       |       |       |         |      |      |           |        |         |        |      |   |            |       |        |       |        |      |          |        |        |     |        |      |  |             |       |        |        |         |      |        |                  |        |      |        |       |
| Terra  | Verde/Giallo     |       |        |       |         |      |       |                |        |      |        |       |   |                |         |       |        |        |      |       |              |        |      |        |      |  |              |        |        |         |        |     |       |              |        |        |        |      |  |             |       |       |       |         |      |      |           |        |         |        |      |   |            |       |        |       |        |      |          |        |        |     |        |      |  |             |       |        |        |         |      |        |                  |        |      |        |       |
| DALI +   | Grigio           |       |        |       |         |      |       |                |        |      |        |       |   |                |         |       |        |        |      |       |              |        |      |        |      |  |              |        |        |         |        |     |       |              |        |        |        |      |  |             |       |       |       |         |      |      |           |        |         |        |      |   |            |       |        |       |        |      |          |        |        |     |        |      |  |             |       |        |        |         |      |        |                  |        |      |        |       |
| DALI -   | Nero             |       |        |       |         |      |       |                |        |      |        |       |   |                |         |       |        |        |      |       |              |        |      |        |      |  |              |        |        |         |        |     |       |              |        |        |        |      |  |             |       |       |       |         |      |      |           |        |         |        |      |   |            |       |        |       |        |      |          |        |        |     |        |      |  |             |       |        |        |         |      |        |                  |        |      |        |       |
| Bezeichnung  | Farbe            |       |        |       |         |      |       |                |        |      |        |       |   |                |         |       |        |        |      |       |              |        |      |        |      |  |              |        |        |         |        |     |       |              |        |        |        |      |  |             |       |       |       |         |      |      |           |        |         |        |      |   |            |       |        |       |        |      |          |        |        |     |        |      |  |             |       |        |        |         |      |        |                  |        |      |        |       |
| Aktiv  | Braun            |       |        |       |         |      |       |                |        |      |        |       |   |                |         |       |        |        |      |       |              |        |      |        |      |  |              |        |        |         |        |     |       |              |        |        |        |      |  |             |       |       |       |         |      |      |           |        |         |        |      |   |            |       |        |       |        |      |          |        |        |     |        |      |  |             |       |        |        |         |      |        |                  |        |      |        |       |
| Neutral  | Blau             |       |        |       |         |      |       |                |        |      |        |       |   |                |         |       |        |        |      |       |              |        |      |        |      |  |              |        |        |         |        |     |       |              |        |        |        |      |  |             |       |       |       |         |      |      |           |        |         |        |      |   |            |       |        |       |        |      |          |        |        |     |        |      |  |             |       |        |        |         |      |        |                  |        |      |        |       |
| Erde   | Grün Gelb        |       |        |       |         |      |       |                |        |      |        |       |   |                |         |       |        |        |      |       |              |        |      |        |      |  |              |        |        |         |        |     |       |              |        |        |        |      |  |             |       |       |       |         |      |      |           |        |         |        |      |   |            |       |        |       |        |      |          |        |        |     |        |      |  |             |       |        |        |         |      |        |                  |        |      |        |       |
| DALI +   | Schwarz          |       |        |       |         |      |       |                |        |      |        |       |   |                |         |       |        |        |      |       |              |        |      |        |      |  |              |        |        |         |        |     |       |              |        |        |        |      |  |             |       |       |       |         |      |      |           |        |         |        |      |   |            |       |        |       |        |      |          |        |        |     |        |      |  |             |       |        |        |         |      |        |                  |        |      |        |       |
| DALI -   | Grau             |       |        |       |         |      |       |                |        |      |        |       |   |                |         |       |        |        |      |       |              |        |      |        |      |  |              |        |        |         |        |     |       |              |        |        |        |      |  |             |       |       |       |         |      |      |           |        |         |        |      |   |            |       |        |       |        |      |          |        |        |     |        |      |  |             |       |        |        |         |      |        |                  |        |      |        |       |
| Aanwijzing   | Kleur            |       |        |       |         |      |       |                |        |      |        |       |   |                |         |       |        |        |      |       |              |        |      |        |      |  |              |        |        |         |        |     |       |              |        |        |        |      |  |             |       |       |       |         |      |      |           |        |         |        |      |   |            |       |        |       |        |      |          |        |        |     |        |      |  |             |       |        |        |         |      |        |                  |        |      |        |       |
| Actief   | Bruin            |       |        |       |         |      |       |                |        |      |        |       |   |                |         |       |        |        |      |       |              |        |      |        |      |  |              |        |        |         |        |     |       |              |        |        |        |      |  |             |       |       |       |         |      |      |           |        |         |        |      |   |            |       |        |       |        |      |          |        |        |     |        |      |  |             |       |        |        |         |      |        |                  |        |      |        |       |
| Neutre   | Bleu             |       |        |       |         |      |       |                |        |      |        |       |   |                |         |       |        |        |      |       |              |        |      |        |      |  |              |        |        |         |        |     |       |              |        |        |        |      |  |             |       |       |       |         |      |      |           |        |         |        |      |   |            |       |        |       |        |      |          |        |        |     |        |      |  |             |       |        |        |         |      |        |                  |        |      |        |       |
| Neutrale   | Blaauw           |       |        |       |         |      |       |                |        |      |        |       |   |                |         |       |        |        |      |       |              |        |      |        |      |  |              |        |        |         |        |     |       |              |        |        |        |      |  |             |       |       |       |         |      |      |           |        |         |        |      |   |            |       |        |       |        |      |          |        |        |     |        |      |  |             |       |        |        |         |      |        |                  |        |      |        |       |
| DALI +   | Grå              |       |        |       |         |      |       |                |        |      |        |       |   |                |         |       |        |        |      |       |              |        |      |        |      |  |              |        |        |         |        |     |       |              |        |        |        |      |  |             |       |       |       |         |      |      |           |        |         |        |      |   |            |       |        |       |        |      |          |        |        |     |        |      |  |             |       |        |        |         |      |        |                  |        |      |        |       |
| DALI -   | Sort             |       |        |       |         |      |       |                |        |      |        |       |   |                |         |       |        |        |      |       |              |        |      |        |      |  |              |        |        |         |        |     |       |              |        |        |        |      |  |             |       |       |       |         |      |      |           |        |         |        |      |   |            |       |        |       |        |      |          |        |        |     |        |      |  |             |       |        |        |         |      |        |                  |        |      |        |       |
| Designacion  | Color            |       |        |       |         |      |       |                |        |      |        |       |   |                |         |       |        |        |      |       |              |        |      |        |      |  |              |        |        |         |        |     |       |              |        |        |        |      |  |             |       |       |       |         |      |      |           |        |         |        |      |   |            |       |        |       |        |      |          |        |        |     |        |      |  |             |       |        |        |         |      |        |                  |        |      |        |       |
| Activo   | Marrón           |       |        |       |         |      |       |                |        |      |        |       |   |                |         |       |        |        |      |       |              |        |      |        |      |  |              |        |        |         |        |     |       |              |        |        |        |      |  |             |       |       |       |         |      |      |           |        |         |        |      |   |            |       |        |       |        |      |          |        |        |     |        |      |  |             |       |        |        |         |      |        |                  |        |      |        |       |
| Neutral  | Azul             |       |        |       |         |      |       |                |        |      |        |       |   |                |         |       |        |        |      |       |              |        |      |        |      |  |              |        |        |         |        |     |       |              |        |        |        |      |  |             |       |       |       |         |      |      |           |        |         |        |      |   |            |       |        |       |        |      |          |        |        |     |        |      |  |             |       |        |        |         |      |        |                  |        |      |        |       |
| Tierra   | Verde / Amarilla |       |        |       |         |      |       |                |        |      |        |       |   |                |         |       |        |        |      |       |              |        |      |        |      |  |              |        |        |         |        |     |       |              |        |        |        |      |  |             |       |       |       |         |      |      |           |        |         |        |      |   |            |       |        |       |        |      |          |        |        |     |        |      |  |             |       |        |        |         |      |        |                  |        |      |        |       |
| DALI +   | Gris             |       |        |       |         |      |       |                |        |      |        |       |   |                |         |       |        |        |      |       |              |        |      |        |      |  |              |        |        |         |        |     |       |              |        |        |        |      |  |             |       |       |       |         |      |      |           |        |         |        |      |   |            |       |        |       |        |      |          |        |        |     |        |      |  |             |       |        |        |         |      |        |                  |        |      |        |       |
| DALI -   | Negro            |       |        |       |         |      |       |                |        |      |        |       |   |                |         |       |        |        |      |       |              |        |      |        |      |  |              |        |        |         |        |     |       |              |        |        |        |      |  |             |       |       |       |         |      |      |           |        |         |        |      |   |            |       |        |       |        |      |          |        |        |     |        |      |  |             |       |        |        |         |      |        |                  |        |      |        |       |

### Non-Dimmable (3-Core) – North America

| EN   | FR               | ES    |        |       |         |       |       |                |   |                |         |       |        |        |      |       |              |   |             |       |        |        |         |      |        |                  |
|--|------------------|-------|--------|-------|---------|-------|-------|----------------|---|----------------|---------|-------|--------|--------|------|-------|--------------|---|-------------|-------|--------|--------|---------|------|--------|------------------|
| <table border="1"> <thead> <tr> <th>Designation</th> <th>Color</th> </tr> </thead> <tbody> <tr> <td>Active</td> <td>Black</td> </tr> <tr> <td>Neutral</td> <td>White</td> </tr> <tr> <td>Earth</td> <td>Green / Yellow</td> </tr> </tbody> </table> <p><i>Do not Hi-Pot test</i></p> | Designation      | Color | Active | Black | Neutral | White | Earth | Green / Yellow | <table border="1"> <thead> <tr> <th>La désignation</th> <th>Couleur</th> </tr> </thead> <tbody> <tr> <td>Actif</td> <td>Marron</td> </tr> <tr> <td>Neutre</td> <td>Bleu</td> </tr> <tr> <td>Terre</td> <td>Vert / Jaune</td> </tr> </tbody> </table> <p><i>Ne pas tester Hi-Pot</i></p> | La désignation | Couleur | Actif | Marron | Neutre | Bleu | Terre | Vert / Jaune | <table border="1"> <thead> <tr> <th>Designacion</th> <th>Color</th> </tr> </thead> <tbody> <tr> <td>Activo</td> <td>Marrón</td> </tr> <tr> <td>Neutral</td> <td>Azul</td> </tr> <tr> <td>Tierra</td> <td>Verde / Amarilla</td> </tr> </tbody> </table> <p><i>No pruebe Hi-Pot</i></p> | Designacion | Color | Activo | Marrón | Neutral | Azul | Tierra | Verde / Amarilla |
| Designation  | Color            |       |        |       |         |       |       |                |   |                |         |       |        |        |      |       |              |   |             |       |        |        |         |      |        |                  |
| Active   | Black            |       |        |       |         |       |       |                |   |                |         |       |        |        |      |       |              |   |             |       |        |        |         |      |        |                  |
| Neutral  | White            |       |        |       |         |       |       |                |   |                |         |       |        |        |      |       |              |   |             |       |        |        |         |      |        |                  |
| Earth  | Green / Yellow   |       |        |       |         |       |       |                |   |                |         |       |        |        |      |       |              |   |             |       |        |        |         |      |        |                  |
| La désignation   | Couleur          |       |        |       |         |       |       |                |   |                |         |       |        |        |      |       |              |   |             |       |        |        |         |      |        |                  |
| Actif  | Marron           |       |        |       |         |       |       |                |   |                |         |       |        |        |      |       |              |   |             |       |        |        |         |      |        |                  |
| Neutre   | Bleu             |       |        |       |         |       |       |                |   |                |         |       |        |        |      |       |              |   |             |       |        |        |         |      |        |                  |
| Terre  | Vert / Jaune     |       |        |       |         |       |       |                |   |                |         |       |        |        |      |       |              |   |             |       |        |        |         |      |        |                  |
| Designacion  | Color            |       |        |       |         |       |       |                |   |                |         |       |        |        |      |       |              |   |             |       |        |        |         |      |        |                  |
| Activo   | Marrón           |       |        |       |         |       |       |                |   |                |         |       |        |        |      |       |              |   |             |       |        |        |         |      |        |                  |
| Neutral  | Azul             |       |        |       |         |       |       |                |   |                |         |       |        |        |      |       |              |   |             |       |        |        |         |      |        |                  |
| Tierra   | Verde / Amarilla |       |        |       |         |       |       |                |   |                |         |       |        |        |      |       |              |   |             |       |        |        |         |      |        |                  |

### 0-10 V (5-Core) – North America

| EN   | FR               | ES    |        |       |         |       |       |                |          |        |          |      |   |                |         |       |        |        |      |       |              |          |        |          |      |   |             |       |        |        |         |      |        |                  |          |        |          |      |
|--|------------------|-------|--------|-------|---------|-------|-------|----------------|----------|--------|----------|------|---|----------------|---------|-------|--------|--------|------|-------|--------------|----------|--------|----------|------|---|-------------|-------|--------|--------|---------|------|--------|------------------|----------|--------|----------|------|
| <table border="1"> <thead> <tr> <th>Designation</th> <th>Color</th> </tr> </thead> <tbody> <tr> <td>Active</td> <td>Black</td> </tr> <tr> <td>Neutral</td> <td>White</td> </tr> <tr> <td>Earth</td> <td>Green / Yellow</td> </tr> <tr> <td>0-10 V +</td> <td>Purple</td> </tr> <tr> <td>0-10 V -</td> <td>Grey</td> </tr> </tbody> </table> <p><i>Do not Hi-Pot test</i></p> | Designation      | Color | Active | Black | Neutral | White | Earth | Green / Yellow | 0-10 V + | Purple | 0-10 V - | Grey | <table border="1"> <thead> <tr> <th>La désignation</th> <th>Couleur</th> </tr> </thead> <tbody> <tr> <td>Actif</td> <td>Marron</td> </tr> <tr> <td>Neutre</td> <td>Bleu</td> </tr> <tr> <td>Terre</td> <td>Vert / Jaune</td> </tr> <tr> <td>0-10 V +</td> <td>Violet</td> </tr> <tr> <td>0-10 V -</td> <td>Gris</td> </tr> </tbody> </table> <p><i>Ne pas tester Hi-Pot</i></p> | La désignation | Couleur | Actif | Marron | Neutre | Bleu | Terre | Vert / Jaune | 0-10 V + | Violet | 0-10 V - | Gris | <table border="1"> <thead> <tr> <th>Designacion</th> <th>Color</th> </tr> </thead> <tbody> <tr> <td>Activo</td> <td>Marrón</td> </tr> <tr> <td>Neutral</td> <td>Azul</td> </tr> <tr> <td>Tierra</td> <td>Verde / Amarilla</td> </tr> <tr> <td>0-10 V +</td> <td>Morado</td> </tr> <tr> <td>0-10 V -</td> <td>Gris</td> </tr> </tbody> </table> <p><i>No pruebe Hi-Pot</i></p> | Designacion | Color | Activo | Marrón | Neutral | Azul | Tierra | Verde / Amarilla | 0-10 V + | Morado | 0-10 V - | Gris |
| Designation  | Color            |       |        |       |         |       |       |                |          |        |          |      |   |                |         |       |        |        |      |       |              |          |        |          |      |   |             |       |        |        |         |      |        |                  |          |        |          |      |
| Active   | Black            |       |        |       |         |       |       |                |          |        |          |      |   |                |         |       |        |        |      |       |              |          |        |          |      |   |             |       |        |        |         |      |        |                  |          |        |          |      |
| Neutral  | White            |       |        |       |         |       |       |                |          |        |          |      |   |                |         |       |        |        |      |       |              |          |        |          |      |   |             |       |        |        |         |      |        |                  |          |        |          |      |
| Earth  | Green / Yellow   |       |        |       |         |       |       |                |          |        |          |      |   |                |         |       |        |        |      |       |              |          |        |          |      |   |             |       |        |        |         |      |        |                  |          |        |          |      |
| 0-10 V +   | Purple           |       |        |       |         |       |       |                |          |        |          |      |   |                |         |       |        |        |      |       |              |          |        |          |      |   |             |       |        |        |         |      |        |                  |          |        |          |      |
| 0-10 V -   | Grey             |       |        |       |         |       |       |                |          |        |          |      |   |                |         |       |        |        |      |       |              |          |        |          |      |   |             |       |        |        |         |      |        |                  |          |        |          |      |
| La désignation   | Couleur          |       |        |       |         |       |       |                |          |        |          |      |   |                |         |       |        |        |      |       |              |          |        |          |      |   |             |       |        |        |         |      |        |                  |          |        |          |      |
| Actif  | Marron           |       |        |       |         |       |       |                |          |        |          |      |   |                |         |       |        |        |      |       |              |          |        |          |      |   |             |       |        |        |         |      |        |                  |          |        |          |      |
| Neutre   | Bleu             |       |        |       |         |       |       |                |          |        |          |      |   |                |         |       |        |        |      |       |              |          |        |          |      |   |             |       |        |        |         |      |        |                  |          |        |          |      |
| Terre  | Vert / Jaune     |       |        |       |         |       |       |                |          |        |          |      |   |                |         |       |        |        |      |       |              |          |        |          |      |   |             |       |        |        |         |      |        |                  |          |        |          |      |
| 0-10 V +   | Violet           |       |        |       |         |       |       |                |          |        |          |      |   |                |         |       |        |        |      |       |              |          |        |          |      |   |             |       |        |        |         |      |        |                  |          |        |          |      |
| 0-10 V -   | Gris             |       |        |       |         |       |       |                |          |        |          |      |   |                |         |       |        |        |      |       |              |          |        |          |      |   |             |       |        |        |         |      |        |                  |          |        |          |      |
| Designacion  | Color            |       |        |       |         |       |       |                |          |        |          |      |   |                |         |       |        |        |      |       |              |          |        |          |      |   |             |       |        |        |         |      |        |                  |          |        |          |      |
| Activo   | Marrón           |       |        |       |         |       |       |                |          |        |          |      |   |                |         |       |        |        |      |       |              |          |        |          |      |   |             |       |        |        |         |      |        |                  |          |        |          |      |
| Neutral  | Azul             |       |        |       |         |       |       |                |          |        |          |      |   |                |         |       |        |        |      |       |              |          |        |          |      |   |             |       |        |        |         |      |        |                  |          |        |          |      |
| Tierra   | Verde / Amarilla |       |        |       |         |       |       |                |          |        |          |      |   |                |         |       |        |        |      |       |              |          |        |          |      |   |             |       |        |        |         |      |        |                  |          |        |          |      |
| 0-10 V +   | Morado           |       |        |       |         |       |       |                |          |        |          |      |   |                |         |       |        |        |      |       |              |          |        |          |      |   |             |       |        |        |         |      |        |                  |          |        |          |      |
| 0-10 V -   | Gris             |       |        |       |         |       |       |                |          |        |          |      |   |                |         |       |        |        |      |       |              |          |        |          |      |   |             |       |        |        |         |      |        |                  |          |        |          |      |

## Dimensions

Dimensions | Dimensioni | Maße | Dimensioner | Dimensiones

